



Aqueous HCl electrolysis utilizing an oxygen reducing cathode

F. Mohammadi^a, S.N. Ashrafzadeh^{b,*}, A. Sattari^b

^a Iran Polymer and Petrochemical Institute, P. O. Box 14965/115, Tehran, Iran

^b Research Lab for Advanced Separation Processes, Department of Chemical Engineering, Iran University of Science and Technology, Narmak, Tehran 1684613114, Iran

ARTICLE INFO

Article history:

Received 23 May 2009

Received in revised form 18 August 2009

Accepted 28 August 2009

Keywords:

Aqueous HCl

Electrolysis

Oxygen reducing cathode

Membrane

CCE

MEA

ABSTRACT

The effects of various process parameters on the cell voltage and chlorine current efficiency (CCE) in a Half-MEA (Nafion[®] 115 membrane-Loading: 0.4 mg Pt/cm²) oxygen reducing membrane electrolysis cell employing a dimensionally stable anode (DSA[®]) were studied. Process parameters under investigation included anolyte concentration, anolyte flow rate, anolyte temperature, oxygen flow rate and applied current density. The effect of the latter parameters on the cell voltage and CCE was determined quantitatively. Taguchi and ANOVA techniques were employed for experimental design and data analysis, respectively.

It was observed that increasing either of anolyte flow rate, anolyte concentration, oxygen flow rate and anolyte temperature caused a decrease in cell voltage and an increase in CCE. At the same time, increasing current density linearly increased cell voltage. Current density and the anolyte flow rate had the highest contributions, of 49.7% and 30.62%, to the cell voltage, respectively. On the other hand, the oxygen flow rate and the anolyte flow rate had the highest contributions, of 57.19% and 23.66%, on the CCE, respectively.

© 2009 Elsevier B.V. All rights reserved.

1. Introduction

Hydrogen chloride (HCl) is a by-product of many manufacturing processes that use chlorine. For example, chlorine is used to manufacture polyvinylchloride, isocyanates, and chlorinated/fluorinated hydrocarbons, with hydrogen chloride as a by-product of these processes. The produced hydrogen chloride cannot be easily sold or used, even after careful purification. Shipment over long distances is not economically feasible as well. Discharge of the acid or chloride ions into wastewater streams is environmentally prohibited. Therefore, recovery and feedback of the chlorine to the manufacturing process is the most desirable route for handling the HCl by-product. A number of commercial processes have been developed to convert HCl into usable chlorine gas [1,2].

Electrochemical processes exist for converting aqueous HCl to chlorine gas by passage of direct electrical current through the solution. The current electrochemical commercial process is known as "Uhde" process. In this process, aqueous HCl of about 22 wt% is fed at 65–80 °C to both compartments of an electrochemical cell, where exposure to a direct current in the cell results in an electrochemical reaction and a decrease in HCl concentration to 17 wt%, with the production of chlorine and hydrogen gases. A polymeric separator divides the two compartments.

The solid polymer electrolyte membrane can be any suitable membrane, and is generally a fluorinated ion exchange membrane of the cationic type, more specifically, a proton conducting membrane. The membrane is typically a commercial cationic membrane made of a fluoro or perfluoro polymer, preferably a copolymer of two or more fluoro or perfluoro monomers, at least one of which has pendant sulfonic acid groups. Suitable membranes are available from E. I. du Pont de Nemours and Company, Wilmington, Del., under the trademark "NAFION", hereinafter referred to as Nafion[®]. In particular, Nafion[®] membranes containing pendant sulfonic acid groups include Nafion[®] 117, Nafion[®] 324, Nafion[®] 417, and Nafion[®] 115. Other membranes that can be used include those produced by radiation grafting or other techniques.

The process requires recycling of the dilute HCl solution (17 wt%). This is generally done by absorbing gaseous anhydrous HCl to regenerate HCl solution of 22 wt% as the feed of the cell. This means that process is generally operated on anhydrous HCl feed even though the medium is aqueous. If HCl concentration becomes too low, a side reaction may occur whereby oxygen is generated from the water present in the system, which increases operating costs. Further, use of HCl as the supporting electrolyte in the Uhde system limits current densities at which the cells can perform to less than 500 A/ft² (5.4 kA/m²). As HCl is converted to chlorine, the electrolyte becomes depleted of ions, increasing resistance to the flow of current and, potentially, causing side reactions to occur. Aqueous HCl that is present in the gap between the electrodes serves both for the electrolyte and the reactant for chlorine evolution [3–5].

* Corresponding author. Tel.: +98 21 77240402; fax: +98 21 77240309.
E-mail address: ashrafi@iust.ac.ir (S.N. Ashrafzadeh).

Current density is related to the reaction rate. Higher current densities provide higher reaction rates, allowing for smaller reactors, and therefore lower investment. Cell voltage is related to energy requirements for the process. Lower cell voltage requires less energy and therefore lower operating costs. Lower oxygen evolution reduces current efficiency losses and corrosion of carbon-based cell components. Optionally, oxygen or a reducible metal ion can be fed to the cathode in order to lower the operating cell voltage. This would result in lower power consumption and therefore lower operating costs. The metal can be selected from the group comprising iron (III), copper (II), cerium (IV), cobalt (III), gold (III), and silver (II). In this study, pure oxygen was selected as the reducing agent [5,6].

The main aim of this study is thus to investigate the impact of operating parameters on cell performance. The well known Taguchi method was employed for experimental design while the ANOVA technique was used for data analysis. The Taguchi procedure and ANOVA technique followed in this study are well described elsewhere [7,8]. As far as we know, there has been no published literature on a systematic investigation of the effects of operating parameters on the performance of an HCl electrolysis membrane cell. The process parameters studied at four levels are anolyte concentration (18–21 wt%), anolyte flow rate (200–500 mL/min), anolyte temperature (45–75 °C), oxygen flow rate (200–900 mL/min) and applied current density (1–4 kA/m²). Already the effects of process parameters of a chlor-alkali cell are studied and optimized by these two research labs [9–11]. An oxygen reducing cathode was used since this advanced method can reduce the cell voltage by 30%. To the knowledge of the current authors, there have been very few published works on the HCl electrolysis process [12].

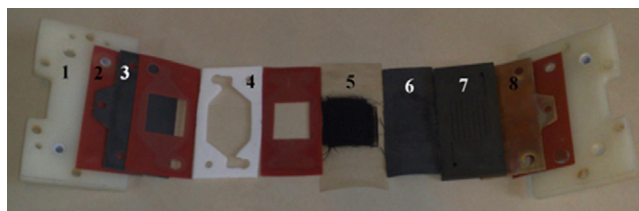

Fig. 1. Components of the membrane cell used in this study: (1) structural support-polypropylene, (2) gasket-silicon®, (3) anode-DSA®, (4) spacer-teflon®, (5) MEA, (6) GDL, (7) gas distributor-graphite and (8) current distributor-copper.

2. Materials and methods

2.1. Chemicals

All chemicals were prepared from analytical grades (Merck Inc.). Deionized water was used for all preparing or washing applications.

2.2. Experimental set-up

The electrochemical cell was a divided filter-press type (Micro-flow cell, Electrocell AB, Sweden) with 10 cm² (3.3 cm × 3 cm) electrode area. A solid polymer electrolyte membrane (Nafion® 115) divided the anode side of the reactor from the cathode side. The anode was a dimensionally stable anode (DSA®) and the cathode was electrocatalytic material directly deposited on the membrane (Half-MEA. Loading: 0.4 mg Pt/cm²). The anode flow field was made from ~2 mm Teflon® as spacer. Carbon cloth backing was placed on the electrocatalytic layer of the Half-MEA and was used as a gas diffusion layer (GDL). A particular graphite block

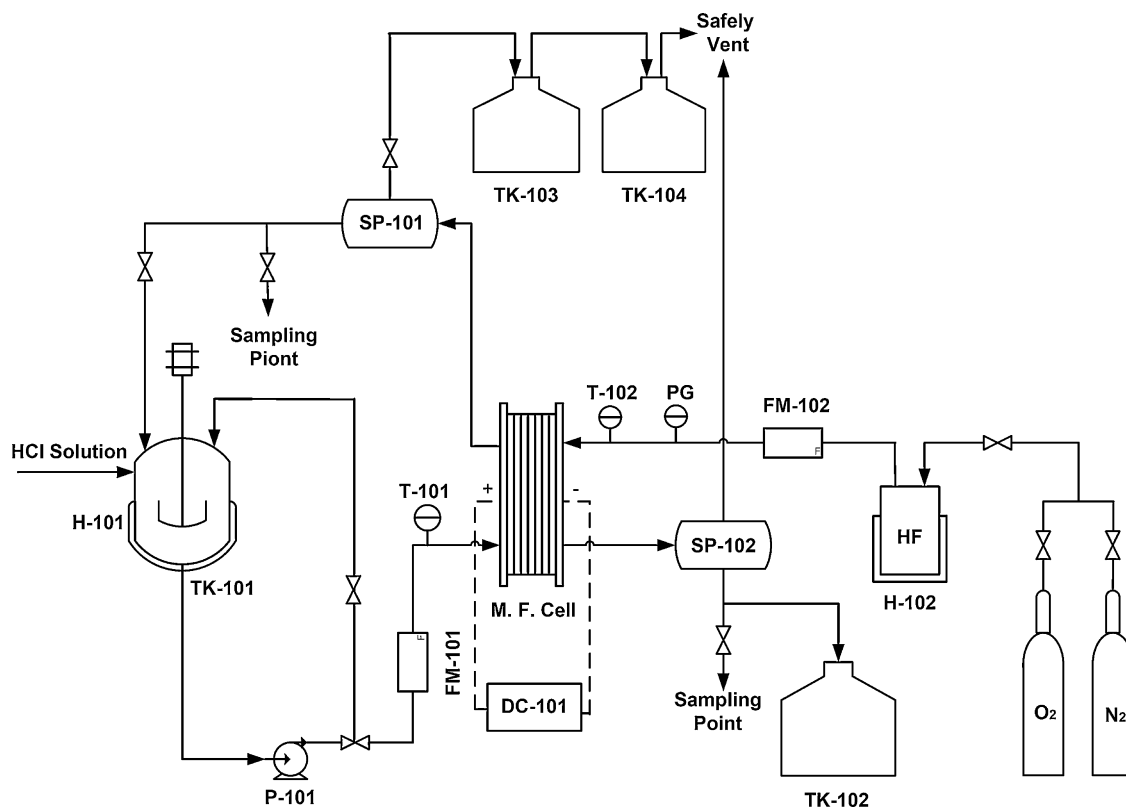

Fig. 2. Process flow diagram of the HCl electrolysis set-up utilized: TK-101 (anolyte recirculation tank), TK-102 (Water product tank), TK-103, 104 (chlorine absorption tanks), SP-101, 102 (gas-liquid separator), FM-101 (liquid flow meter), FM-102 (oxygen flow meter), T-101, 102 (temperature indicators), DC-101 (DC power supply), H-101, 102 (jacketed electrical heaters), P-101 (anolyte magnetic pump), PG (pressure gauge), HF (humidifier), M.F. Cell (membrane flow cell).

Table 1
Taguchi L₁₆ orthogonal array with integers representing the levels of each parameter.

Operating parameter	Run number															
	1	2	3	4	5	6	7	8	9	10	11	12	13	14	15	16
Anolyte flow rate	1	1	1	1	2	2	2	2	3	3	3	3	4	4	4	4
Anolyte concentration	1	2	3	4	1	2	3	4	1	2	3	4	1	2	3	4
Oxygen flow rate	1	2	3	4	2	1	4	3	3	4	1	2	4	3	2	1
Cell temperature	1	2	3	4	3	4	1	2	4	3	2	1	2	1	4	3
Current density	1	2	3	4	4	3	2	1	2	1	4	3	3	4	1	2

having patterned channels for gas/liquid distribution was allocated right after the GDL. Electric current was directly connected to the anode (DSA[®]) and a copper plate used as current distributor/collector for the cathode side [13–17].

Gaskets made of Silicon[®] with openings cut out for the anode and cathode inlets and outlets were placed between the conductive plates and the membrane to insulate each plate from the membrane (Fig. 1).

Fig. 2 shows the process flow diagram of the set-up used in this study. The acid feed tank was heated by jacketed heater and its temperature was monitored by a digital thermometer.

Aqueous HCl entered the reactor at the anode side through the backing. The anolyte was re-circulated in separate hydraulic circuit throughout each experiment by means of a magnetic pump; see Fig. 2. The overflow from the anolyte compartment of the electrolysis cell was sent to a gas–liquid separator. During electrolysis, Cl₂ gas produced was absorbed by 2 M sodium hydroxide solution in TK-103 and then TK-104, respectively. The cathode chamber was fed with oxygen at atmospheric pressure. Oxygen was fed to the cathode side of the reactor through graphite block. The oxygen stream was heated and humidified by a jacketed bubble column humidifier (HF). To prevent the membrane from drying out, the relative humidity (RH) level for oxygen gas entering the cathode side was set equal to 80%. The temperature and extent of humidification of oxygen was adjusted prior to its entrance to the cathode compartment. In order to minimize the corrosion phenomenon, the feed line of cathode gas was equipped with two valves that would stop the oxygen flow and replace it with nitrogen, upon a power loss. Protons from the anode side of the reactor passed through membrane to the cathode where they reacted and formed water. Water and unreacted oxygen were then discharged from the cathode side of the reactor. Constant currents were applied to the cell and the corresponding cell voltages were measured by a multi-meter. After each test, the set-up was washed thoroughly with deionized water, drained, and dried. Preliminary tests showed that the system reached steady state conditions after 15 min. Therefore, the current density was applied after 15 min from the beginning of each experiment [18].

2.3. Design of experiments

Taguchi L₁₆ array was used to design the experiments. Table 1 is an L₁₆ orthogonal array, a table of integers whose rows elements (1, 2, 3 and 4) represent the levels of the row factors. Each column of the orthogonal array represents a run, that is, a specific set of factors to be tested. The L₁₆ orthogonal array accommodates five factors at four levels each in sixteen runs. The actual values of the factors used in each run are given in Table 2.

2.4. Analysis

Chlorine current efficiency was determined using Iodimetry test of the samples of the anolyte and absorbed with standardized 0.1 M

Table 2
Taguchi L₁₆ orthogonal array with the actual values of each parameter.

Operating parameters	Levels			
	1	2	3	4
Anolyte flow rate [cm ³ /min]	200	300	400	500
Anolyte concentration [wt% HCl]	18	19	20	21
Oxygen flow rate [cm ³ /min]	200	400	650	900
Cell temperature [°C]	45	55	65	75
Current density [kA/m ²]	1	2	3	4

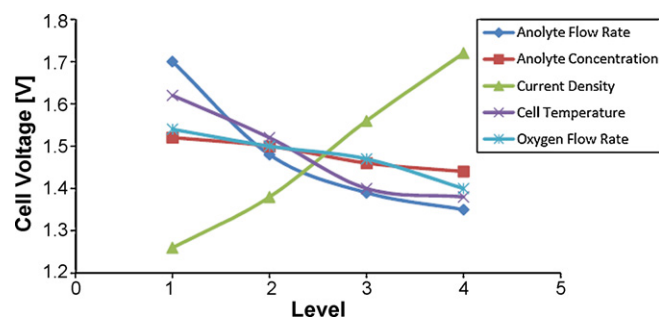

Fig. 3. The effect of various operating parameters on cell voltage.

sodium thiosulphate¹ solution [19]. All Iodimetry tests were carried out for two times and CCE was then calculated using Eq. (1).

Cl₂ current efficiency

$$= \frac{\text{Cl}_2 \text{ moles produced} \times 2 \times \text{Faraday number (C/mol)}}{\text{Current intensity (A)} \times \text{time (s)}} \quad (1)$$

The voltage of the cell was measured using a voltmeter with the accuracy of 0.01 V.

3. Results and discussions

As mentioned above, the experiments were designed and carried out according to Taguchi experimental design method. Meanwhile, each test was at least carried out for two times. The cell voltage was directly obtained from the voltmeter. The CCE was calculated according to Eq. (1), the amount of produced chlorine in moles was obtained from iodimetry tests. Using Qualitek-4 and Minitab-14 software the results were analyzed. Effects of various operating parameters on the cell voltage and CCE are shown in Figs. 3 and 4. The contribution of each process parameter on the system responses and their profile were evaluated and presented in the same figures. It should be noted that in all reported data, except the variable parameter, other parameters are set at their optimum values.

¹ Na₂S₂O₃·6H₂O.

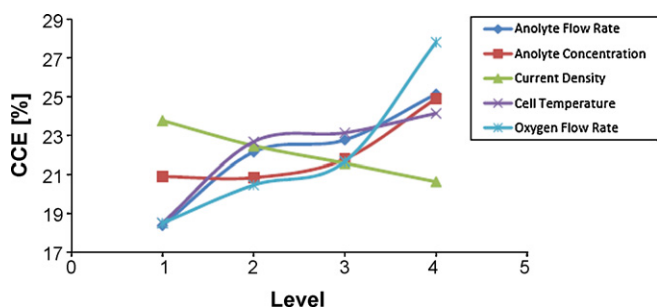

Fig. 4. The effect of various operating parameters on CCE.

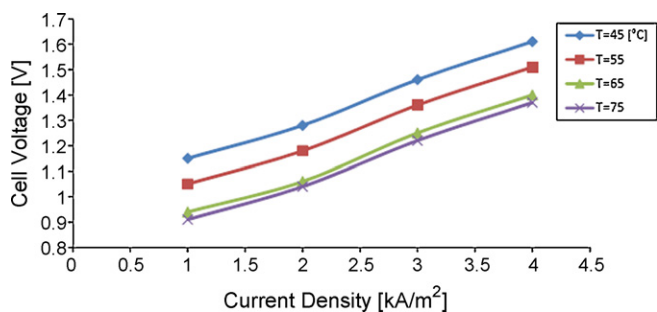
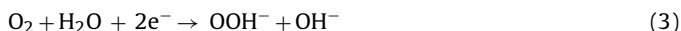

Fig. 5. The effect of current density on cell voltage at different temperatures.

3.1. Effect of current density

In order to investigate the effect of current density on the cell voltage and CCE, the cell was operated at four current densities from 1 to 4 kA/m². The results (Fig. 5) show that increasing current density sharply increased the cell voltage (as it was expected) and the trend is very close to be linear. This result is in complete agreement with Hine et al. report [18].

As it can be seen (Fig. 6), the CCE linearly decreased with current density. Effect of current density on CCE is believed to be originated from the different kinetics of desirable complete 4-electron reduction from that of unwanted partial 2-electron reduction of oxygen:



In fact, any increase in current density would shift the cathode potential towards the more negative values and this phenomenon affects the relative rates of the reactions (2) and (3). The reaction (2) is more favorable because it produces 4 hydroxyl ions per reaction (instead of only 1 hydroxyl ion in the case of reaction 3) that can produce water together with H⁺ ions which permeate across the membrane and consequently enhances the CCE. Higher current densities are likely to decrease CCE by (1) increasing membrane

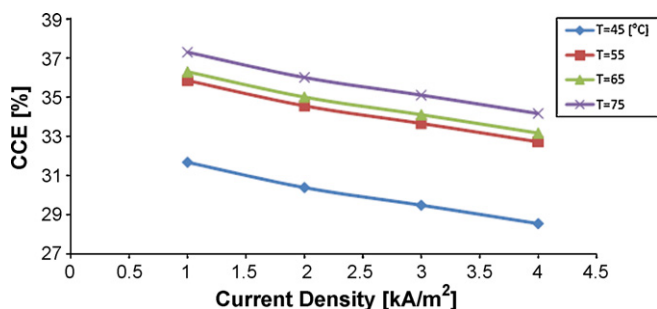

Fig. 6. The effect of current density on CCE at different temperatures.

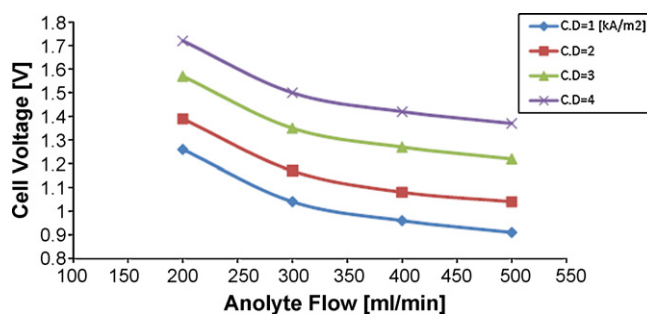

Fig. 7. The effect of anolyte flow rate on cell voltage at different temperatures.

swelling and permeability, (2) more significant contribution of the oxygen evolution reaction and, (3) membrane blinding by chlorine gas in the anode side [20].

3.2. Effect of anolyte flow rate

To see the effect of anolyte flow rate on the cell performance, the anolyte flow rate was tested at four levels of 200, 300, 400 and 500 mL/min. As it can be seen from Figs. 7 and 8, increasing the anolyte flow rate decreases the cell voltage but increases the CCE.

The HCl electrolysis process is a mass transfer control reaction and certain increasing anolyte flow rate increases the mass transfer coefficients of ions in the cell, thus the amount of ions near the electrodes surface increases and this leads to a decrease in cell voltage. Moreover, increasing the anolyte flow rate also increases the Cl⁻ concentration at the anode surface, thus enhancing the electrolysis through preventing the oxygen evolution side reaction (as mentioned earlier). The latter would tend to increase the cell voltage. This result is the same as that reported by Trainham et al. [14]. Increasing the anolyte flow rate increases the amount of the fresh anolyte feed in the anolyte chamber and leads to a higher electrical conductivity; thereby increase in CCE. This result is in complete agreement with the conventional membrane cells [14,18]. The latter might be attributed to the reduction in the amount of attached Cl₂ bubbles on the anodic side of the membrane as well as those remained within the anolyte. In fact, at low anolyte flow rates, the presence of bubbles decreases the effective area of the membrane through blinding effect.

3.3. Effect of anolyte temperature

The effect of anolyte temperature on the cell performance was studied and the results are shown in Figs. 9 and 10. As it can be seen from these figures, increasing the anolyte temperature decreases the cell voltage and increases the CCE. It is known that the electrical conductivity of the electrolyte is a function of concentration and temperature. At high temperatures, the higher conductivity of anolyte solution lowers the cell voltage and therefore reduces

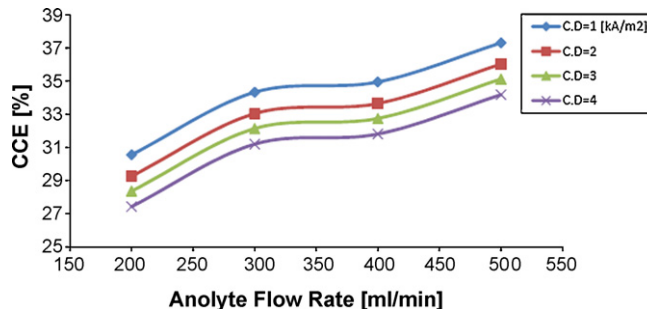

Fig. 8. The effect of anolyte flow rate on CCE at different temperatures.

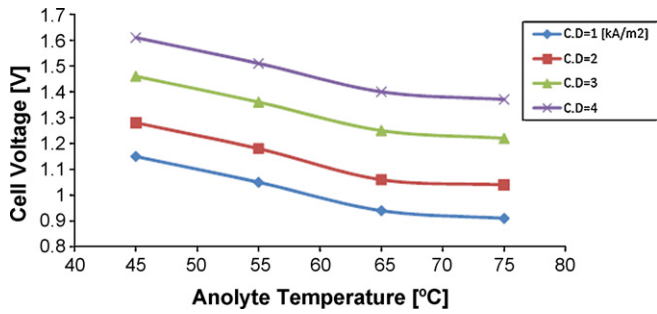

Fig. 9. The effect of anolyte temperature on cell voltage at different current densities.

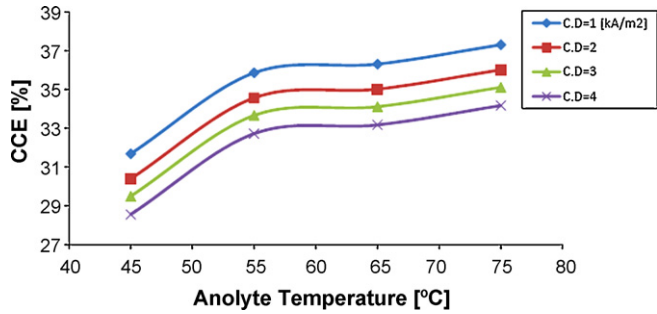

Fig. 10. The effect of anolyte temperature on CCE at different current densities.

the energy consumption of the cell (as in conventional membrane cells) [20]. From electrochemical kinetics point of view, increasing the anolyte temperature improves the reaction kinetics, lowers the Gibbs free energy (ΔG^0) and therefore decreases cell voltage according to the following equations.

$$E_F^0 = -\frac{\Delta G^0}{nF} \quad (4)$$

$$E = E^0 + \frac{RT}{nf} \ln K \quad (5)$$

The latter is the well known Nernst potential equation which relates the electromotive force of an electrochemical reaction to the temperature and concentration. Consequently the economic and energy factors are in favor of the technology that utilizes higher temperatures. These results are in agreement with those of earlier published works [3].

3.4. Effect of oxygen flow rate

By increasing the oxygen flow rate the cell voltage decreased, see Fig. 11. As it was mentioned in Section 1, the oxygen gas is an alternative reducible agent that was chosen as the cathodic side inlet. The electromotive force needed to reduce the oxygen is much lower

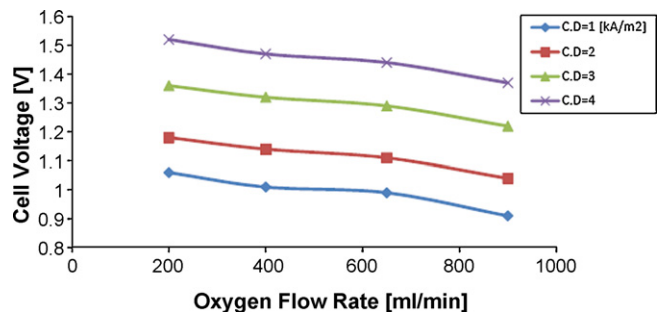

Fig. 11. The effect of oxygen flow rate on cell voltage at different current densities.

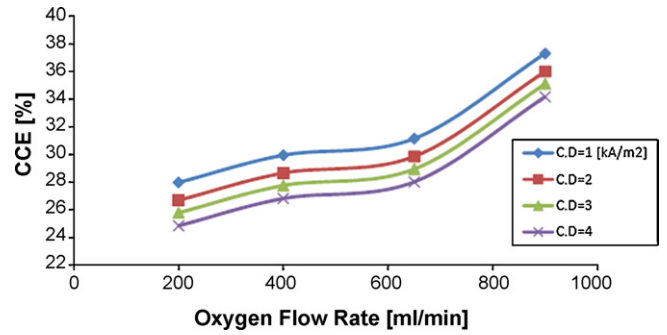

Fig. 12. The effect of oxygen flow rate on CCE at different current densities.

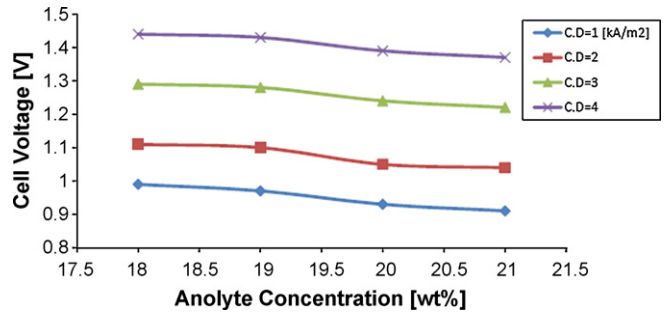
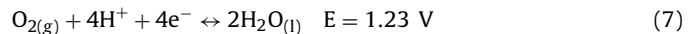
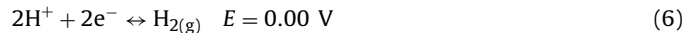

Fig. 13. The effect of anolyte concentration on cell voltage at different current densities.

than that to reduce the H^+ ions, see Eqs. (6) and (7). Consequently, increasing the oxygen flow rate would increase the available oxygen at the cathode surface to be reduced instead of H^+ ions and that reduces the cell voltage.



The effect of oxygen flow rate on CCE was not linear. The results show that CCE increased with increasing oxygen flow rate, see Fig. 12. The observed increase in CCE at higher rates of oxygen flow rate most likely results from the effect of gas flow on the effectiveness of removal of the produced water from the electrode surface. Higher gas velocities in the cathode chamber make the removal of water from the electrode pores easier than that at low velocities. In very low gas velocities, there was an accumulation of water in the cathode chamber that reduced the efficiency of the gas diffusion from cathode. These results are in agreement with prior studies [6].

3.5. Effect of anolyte concentration

The effect of acid concentration on cell voltage and CCE was studied and the results are shown in Figs. 13 and 14. As it can

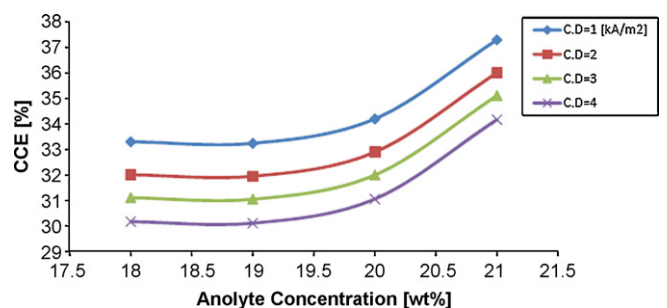

Fig. 14. The effect of anolyte concentration on CCE at different current densities.

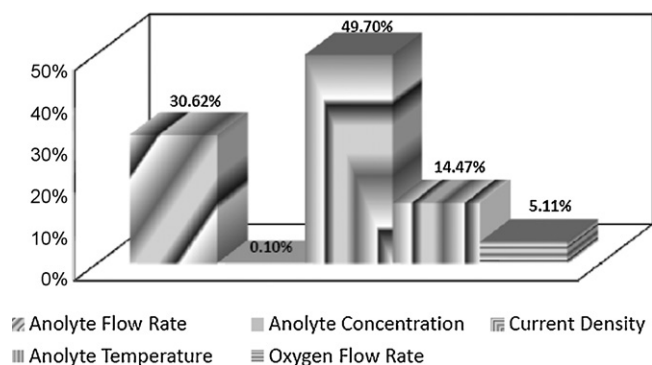

Fig. 15. The contribution of each process parameter on cell voltage.

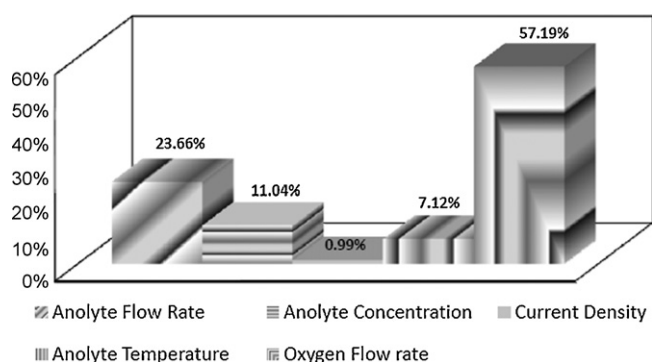

Fig. 16. The contribution of each process parameter on CCE.

be seen, like conventional membrane cells [20], the cell voltage decreases almost linearly with acid concentration while increasing the concentration increases CCE, within the range of study. It has been postulated that by increasing the anolyte concentration its electrical conductivity increases and consequently decreases the cell voltage. On the other hand, as mentioned in the previous sections, lower HCl concentrations, i.e. lower Cl^- ions at the anode surface, leads to an unwanted side reaction whereby oxygen is generated from the water present in the system. Consequently increasing the anolyte concentration prevents such a side reaction and decreases the cell voltage. This result is in agreement with Minz et al. report [3]. On the other hand, at low acid concentrations, the low CCE is due to the low concentration of Cl^- ions in the anolyte. Increasing the anolyte concentration would increase the presence of ions and thus CCE increases [20].

3.6. Sensitivity analysis

The analysis of variance (ANOVA) is often used to determine the factors influencing the mean response (cell voltage and chlorine current efficiency). Contribution of each factor on response (P) based on mean response were calculated using Minitab-14 software and are shown in Figs. 15 and 16. As it can be seen in Fig. 15, current density and acid flow rate with P values of about 49.70% and 30.62% respectively, are the most influencing parameters on HCl electrolysis cell voltage while acid concentration has the lowest effect with P value of 0.1%. However, with respect to chlorine current efficiency, the oxygen flow rate and acid flow rate have the highest contributions (P values) of 57.19% and 23.66% on CCE while the current density has the lowest effect with P value of 0.99% (see Fig. 16).

4. Conclusions

The impact of operating parameters including anolyte concentration, anolyte temperature, anolyte flow rate, oxygen flow rate and current density on the cell voltage and chlorine current efficiency of a laboratory membrane cell for hydrochloric acid electrolysis using an oxygen reduction cathode was thoroughly investigated. The design of experiments was conducted by Taguchi method.

It was observed that increasing anolyte concentration, anolyte temperature, anolyte flow rate and oxygen flow rate decreased the cell voltage and increased CCE. This trend was reverse for the current density; its increase increased the cell voltage and decreased CCE.

Evaluation of the relative effectiveness of operating parameters by ANOVA revealed that the current density and the anolyte flow rate had the highest contributions of 49.7% and 30.62%, to the cell voltage, respectively. At the same time, the oxygen flow rate and the anolyte flow rate had the highest contributions of 57.19% and 23.66% on the CCE, respectively.

Acknowledgements

Authors are grateful for the technical support of Iran Polymer and Petrochemical Institute as well as financial support of Iran University of Science and Technology.

References

- [1] SRI PEP Report, Chlorine by Electrolysis of Hydrogen Chloride, 1970.
- [2] SRI CEH Report, Chlorine and Alkali Chemicals, 2006.
- [3] Franz-Rudolf Minz, Dormagen, Fed, Process for performing HCl membrane electrolysis, US Patent No. 4,725,341 (1988).
- [4] Markus Dugal, Bernd Pennemann, Friedhelm Kamper, Process for the coupled production of chlorine and isocyanates, US Patent No. 0,265,466 A1 (2007).
- [5] Stephen Erwin Lyke, Pallav Tatapudi, Process for aqueous HCl electrolysis with thin film, US Patent No. 6,066,248 (2000).
- [6] S. Motupally, D.T. Mah, F.J. Freire, J.W. Weidner, Recycling chlorine from hydrogen chloride, a new and economical electrolytic process, *Electrochem. Soc. Interf.* (1998).
- [7] T. Mohammadi, A. Moheb, M. Sadrzadeh, A. Razmi, Separation of copper ions by electrodialysis using Taguchi experimental design, *Desalination* 169 (2004) 21–31.
- [8] T. Mohammadi, A. Razmi, M. Sadrzadeh, Effect of operating parameters on Pb^{2+} separation from wastewater using electrodialysis, *Desalination* 167 (2004) 379–385.
- [9] T. Mirzazadeh, F. Mohammadi, M. Soltanieh, E. Joudaki, Optimization of caustic current efficiency in a zero-gap advanced chlor-alkali cell with application of genetic algorithm assisted by artificial neural networks, *Chem. Eng. J.* 140 (2008) 157–164.
- [10] A.A. Jalali, F. Mohammadi, S.N. Ashrafzadeh, Effect of process conditions on cell voltage, current efficiency and voltage balance of a chlor-alkali membrane cell, *Desalination* 237 (2009) 126–139.
- [11] N. Shojai Kaveh, S.N. Ashrafzadeh, F. Mohammadi, Development of an artificial neural network model for prediction of cell voltage and current efficiency in a chlor-alkali membrane cell, *Chem. Eng. Res. Des.* 86 (5) (2008) 461–472.
- [12] E.N. Balko, S.F. McElroy, A.B. Laconti, Halogen acid electrolysis in solid polymer electrolyte cells, *Int. J. Hydrogen Energy* 6 (1981) 577–587.
- [13] Fritz Gestermann, Hans-Dieter Pinter, Gerd Speer, Peter Fabian, Robert Scannel, Electrode for electrolysis in acidic media, US Patent No. 7,211,177 B2 (2007).
- [14] James A. Trainham, Clarence G. Law, John S. Newman, Kenneth B. Keating, Douglas J. Eames, Anode useful for electrochemical conversion of anhydrous hydrogen halide to halogen gas, US Patent No. 5,580,437 (1996).
- [15] James W. McMichael, Lake Jackson, Membrane/electrode combination having interconnected roadways of catalytically active particles, US Patent No. 5,039,389 (1991).
- [16] A.J. Appleby, F.R. Foulkes, N.Y. Van Nostrand Reinhold, *Fuel Cell Handbook*, 1989.
- [17] Frédéric Faverjon, Mohammed Rakib, Gérard Durand, Electrochemical study of a hydrogen diffusion anode-membrane assembly for membrane electrolysis, *J. Electrochem. Acta* 51 (2005) 386–394.
- [18] F. Hine, M. Nazaki, Y. Kurata, Bench scale experiment of recovery of chlorine from waste gas, *J. Electrochem. Soc.* 131 (12) (1984) 57–66.
- [19] Giovanni Piccardi, Roberto Udisti, Determination of chlorine in hydrochloric acid solutions, *Mikrochim. Acta* (1983) 109–114.
- [20] A. Sattari, Hydrogen and chlorine production by recovered HCl membrane electrolysis, MSc Thesis, Department of Chemical Engineering, Iran University of Science and Technology, Tehran, Iran, 2009.